



Project: _____

Location: _____

Fixture Type: _____

Catalog Number: _____

AVAILABLE FINISHES:



Acid

PD-64608

PRODUCT DESCRIPTION

Surrealistic droplets of metallic liquid artfully suspended. Powerful LED downlights concealed within these steel shades provide functional illumination. String individually or droptem in clusters. From single pendants to symphonic chandelier arrangements, these stunning pieces transform any space to an opulent décor dream.

FEATURES

- Driver installed within the Junction Box, driver dimension: 2.8" x 1.3" x 1.2"
- Steel hardware
- Thin powered aircraft cables provide an ultra clean look for adjustable suspension height

SPECIFICATIONS

| | |
|------------------|--------------------------------|
| Rated Life | 70000 Hours |
| Standards | ETL, cETL,Damp Location Listed |
| Input | 120-277V,50/60Hz |
| Driver Dimension | 2.8" x 1.3" x 1.2" |
| Dimming | ELV |
| Color Temp | 3000K |
| CRI | 90 |
| Construction | Steel body with glass diffuser |

REPLACEMENT PARTS

RPL-GLA-64608 - Glass

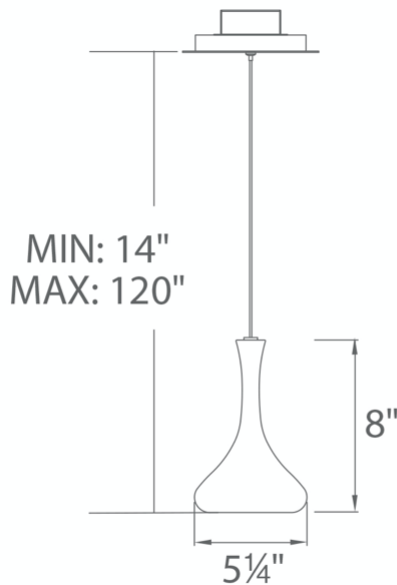

PD-64608

| Model & Size | Color Temp | Finish | LED Watts | LED Lumens | Delivered Lumens |
|--------------|------------|--------------------|-----------|------------|------------------|
| PD-64608 8" | 3000K | PN Polished Nickel | 11W | 690 | 580 |

Example: **PD-64608-PN**

For custom requests please contact customs@modernforms.com