

INSTALLATION INSTRUCTION

FM-W47204/FM-W46204

CAUTION: To prevent electrical shock, ensure electricity has been turned off at the circuit breaker before beginning.

- Read all instructions before installing.
- System is intended for installation by a licensed electrician in accordance with the National Electrical Code (NEC) and local regulations.
- When handling the fixture, do not apply pressure to the LEDs. Hold the fixture by the base only.
- Retain installation instructions for future maintenance reference.

WARNING: All parts must be used as indicated in these instructions. This product is designed for use only with the supplied parts and/or accessories designated for use by WAC. Substitution of parts or accessories not designated for use with this product by WAC could result in personal injury or property damage, and will void the warranty. Contact an authorized dealer or the manufacturer if any parts are damaged or missing.

MAINTENANCE NOTE: Coastal conditions may cause mineral and residue build-up on the fixture. We recommend that customers in coastal areas clean all external surfaces of the fixture once every two weeks with a wet cloth.

MISE EN GARDE: Pour éviter tout choc électrique, assurez-vous que le disjoncteur soit mis hors tension avant de commencer.

- Lisez toutes les instructions avant l'installation.
- Le système doit être installé par un électricien licencié conformément au code national de l'électricité (NEC), et également aux règlements locaux.
- Lors de la manipulation du luminaire, n'appuyez pas sur les LED. Tenez-le uniquement par la base.

ATTENTION: Toutes les pièces doivent être utilisées comme indiqué dans ces instructions. Ce produit est conçu pour être utilisé seulement avec les pièces et/ou accessoires fournis pour être utilisés avec les produits Modern Forms. Remplacer des pièces ou accessoires non conçus pour ce produit Modern Forms pourrait causer des dommages corporels ou matériels et pourrait également causer l'annulation de la garantie. Veuillez contacter un revendeur autorisé ou le fabricant si des pièces manquent ou sont endommagées.

NOTE D'ENTRETIEN: Les conditions côtières peut causer une accumulation de minéraux et de résidu sur le luminaire. Nous recommandons aux clients qui résident dans les zones côtières de nettoyer toutes les surfaces externes du luminaire une fois toutes les deux semaines avec un chiffon humide.

HARDWARE

A



Wire Connector
Qty: 3pcs+1 Extra

B

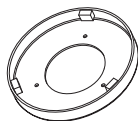

Conversion Plate
Qty: 1pc

C

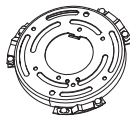

Large Mounting Plate
Qty: 1pc

D



Mounting Screw
Qty: 3pcs+1 Extra

E



Switch Cover
Qty: 1 Extra

F



Plastic Anchor
Qty: 2pcs+1 Extra

G



Wood Screw
Qty: 2pcs+1 Extra

wacighting.com

Phone (800) 526.2588

Fax (800) 526.2585

Headquarters, East Manufacturing Facility

44 Harbor Park Drive

Port Washington, NY 11050

South East Manufacturing Facility

1600 Distribution Ct

Lithia Springs, GA 30122

Central Manufacturing Facility

1700 South J Elmer Freeway, Ste 100

Cedar Hill, TX 75104

West Manufacturing Facility

1750 S Archibald Ave

Ontario, CA 91761

INSTALLATION INSTRUCTION

FM-W47204/FM-W46204

FIG. 1 MOUNT WITHOUT CONVERSION PLATE

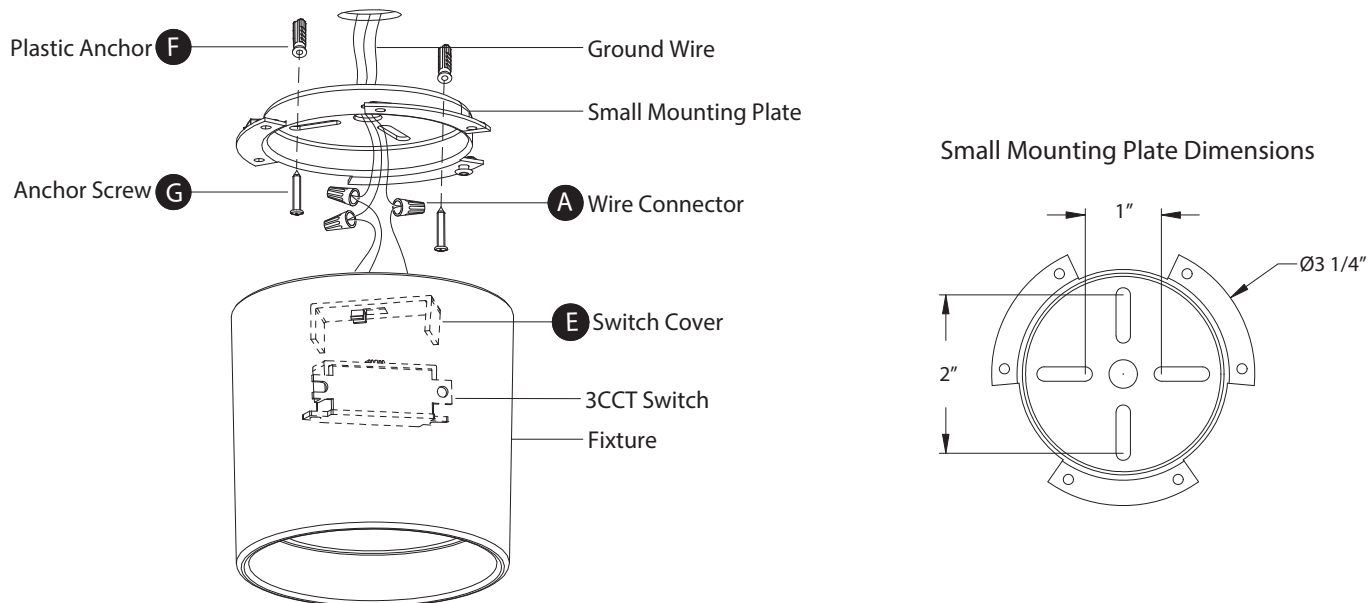

Note: Mounting configuration at customer’s discretion to meet electrical code requirements.

PREPARATION

1. Shut off the power at the circuit breaker and remove existing fixture, including the crossbar.
2. Carefully unpack your new fixture and lay out all the parts on a clear area. Be careful not to lose any small parts necessary for installation.

MOUNT WITHOUT CONVERSION PLATE (Fig. 1)

3. Rotate the fixture and take out the small mounting plate.
4. The lamp can switch between three color temperatures (3000K-3500K-4000K), which can be adjusted to your preference with the 3CCT switch (Fig.3).

Note: (i) The switch comes with a detachable switch cover, remove the switch cover prior to adjusting the color temperature, reattach the switch cover (E) after adjustment is made.

(ii) Fixture must be powered off to adjust the CCT setting, after each CCT adjustment cycle power on, off then on to show new CCT setting.

5. Drill a small access hole in the ceiling behind the fixture and pull the house wires through the ceiling.
6. Drill holes in the ceiling aligned with the key holes located in the small mounting plate. Insert the plastic anchors (F). Fasten the mounting plate to the ceiling with the plastic anchors using the anchor screws (G) provided.
7. Connect the fixture’s wires to house wires as shown in Fig.2, making sure that all wire connectors (A) are secured. If your outlet box has a green or bare copper ground wire, connect the fixture’s ground wire to it. Otherwise, tuck the fixture’s ground wire directly to the fixture. After wires are connected, tuck them carefully inside the fixture.
8. Place the fixture over the mounting plate and tighten it by clockwise rotation.
9. To prevent moisture from entering the fixture, use caulking (i.e. indoor/outdoor silicone sealant) to outline the outside of fixture where it meets the wall (Fig.4).

Fig. 2 Wiring

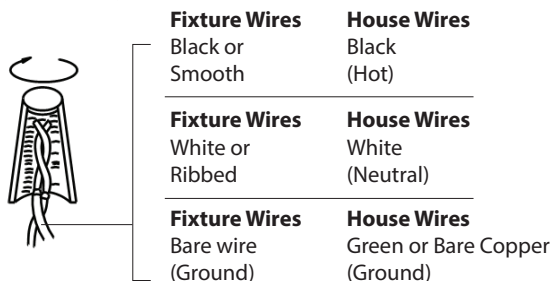

FIG. 3CCT Switch

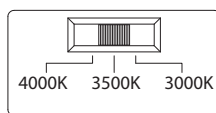
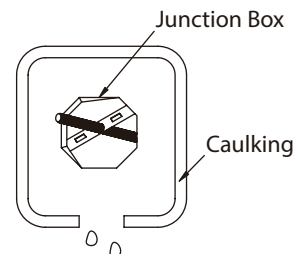

Fig. 4 Caulking



wacighting.com
Phone (800) 526.2588
Fax (800) 526.2585

Headquarters, East Manufacturing Facility
44 Harbor Park Drive
Port Washington, NY 11050

South East Manufacturing Facility
1600 Distribution Ct
Lithia Springs, GA 30122

Central Manufacturing Facility
1700 South J Elmer Freeway, Ste 100
Cedar Hill, TX 75104

West Manufacturing Facility
1750 S Archibald Ave
Ontario, CA 91761

INSTALLATION INSTRUCTION

FM-W47204/FM-W46204

FIG. 5 MOUNT ON THE JUNCTION BOX OR SWITCH BOX

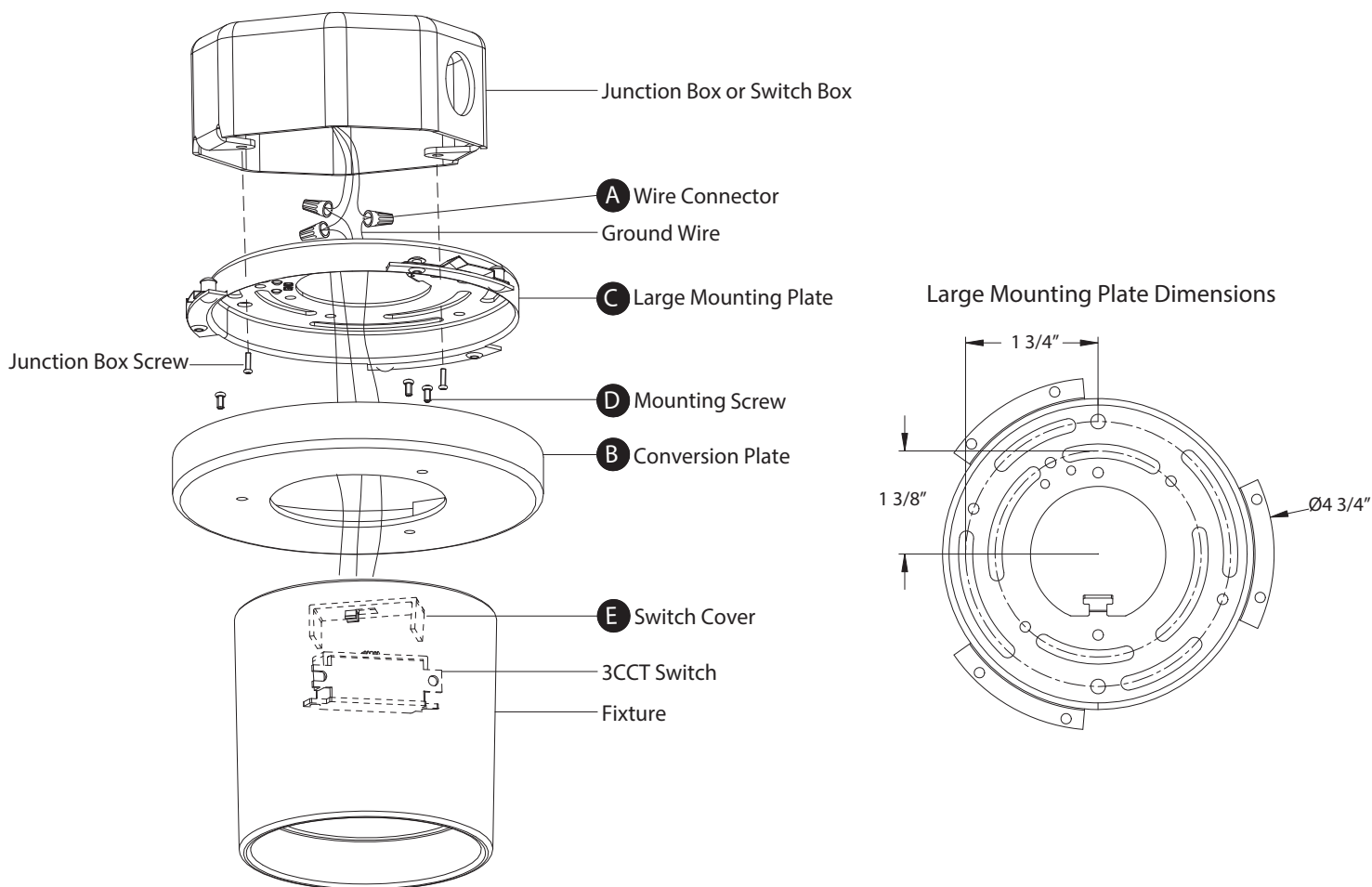

MOUNT ON THE JUNCTION BOX OR SWITCH BOX (Fig. 5)

3. Rotate the fixture and take out all the mounting plates.
 4. The lamp can switch between three color temperatures (3000K-3500K-4000K), which can be adjusted to your preference with the 3CCT switch (Fig.1).
- Note:** (i) The switch comes with a detachable switch cover, remove the switch cover prior to adjusting the color temperature, reattach the switch cover (E) after adjustment is made.
- (ii) Fixture must be powered off to adjust the CCT setting, after each CCT adjustment cycle power on, off then on to show new CCT setting.
5. Place the conversion plate (B) onto the fixture, secure it with 3 of mounting screws (D) .
 6. Secure the large mounting plate to the junction box using standard junction box screws that comes with the junction box.
Note: (i) using any other non-original-manufacturer provided junction box screw may result in safety issue;
(ii) The side of the mounting back plate marked "GND" must face out.
 7. Connect the fixture's wires to junction box or switch box wires as shown in Fig.2, making sure that all wire connectors (A) are secured. If your outlet box has a green or bare copper ground wire, connect the fixture's ground wire to it. Otherwise, tuck the fixture's ground wire directly to the fixture. After wires are connected, tuck them carefully inside the fixture.
 8. Place the fixture over the large mounting plate and tighten it by clockwise rotation.
 9. To prevent moisture from entering the outlet box and causing a short, use clear caulking (i.e. indoor/outdoor silicone sealant) to outline the outside of fixture back plate where it meets the wall (Fig.4).