

INSTALLATION INSTRUCTIONS

399-LED PENDANTS

PD-39947

MODERN FORMS

CAUTION: To prevent electrical shock, ensure electricity has been turned off at the circuit breaker before beginning.

- Read all instructions before installing.
- System is intended for installation by a licensed electrician in accordance with the National Electrical Code (NEC) and local regulations.
- When handling the fixture, do not apply pressure to the LEDs. Hold the fixture by the base only.
- Retain installation instructions for future maintenance reference.

WARNING: All parts must be used as indicated in these instructions. This product is designed for use only with the supplied parts and/or accessories designated for use by Modern Forms. Substitution of parts or accessories not designated for use with this product by Modern Forms could result in personal injury or property damage, and will void the warranty. Contact an authorized dealer or the manufacturer if any parts are damaged or missing.

MAINTENANCE NOTE: Coastal conditions may cause mineral and residue build-up on the fixture. We recommend that customers in coastal areas clean all external surfaces of the fixture once every two weeks with a wet cloth.











MISE EN GARDE: Pour éviter tout choc électrique, assurez-vous que le disjoncteur soit mis hors tension avant de commencer.

- Lisez toutes les instructions avant l'installation.
- Le système doit être installé par un électricien licencié conformément au code national de l'électricité (NEC), et également aux règlements locaux.
- Lors de la manipulation du luminaire, n'appuyez pas sur les LED. Tenez-le uniquement par la base.

ATTENTION: Toutes les pièces doivent être utilisées comme indiqué dans ces instructions. Ce produit est conçu pour être utilisé seulement avec les pièces et/ou accessoires fournis pour être utilisés avec les produits Modern Forms. Remplacer des pièces ou accessoires non conçus pour ce produit Modern Forms pourrait causer des dommages corporels ou matériels et pourrait également causer l'annulation de la garantie. Veuillez contacter un revendeur autorisé ou le fabricant si des pièces manquent ou sont endommagées.

NOTE D'ENTRETIEN: Les conditions côtières peut causer une accumulation de minéraux et de résidus sur le luminaire. Nous recommandons aux clients qui résident dans les zones côtières de nettoyer toutes les surfaces externes du luminaire une fois toutes les deux semaines avec un chiffon humide.

HARDWARE

				
				
Wire Connector Qty: 3PCS+1 Extra	Mounting Screw Qty: 1 Extra	Plastic Anchor Qty:3PCS+1 Extra	Wood Screw Qty:3PCS+1Extra	Set Screw Qty: 1 Extra

modernforms.com
Phone (800) 526.2588
Fax (800) 526.2585

Headquarters/Eastern Distribution Center
44 Harbor Park Drive
Port Washington, NY 11050

Central Distribution Center
1600 Distribution Ct
Lithia Springs, GA 30122

Western Distribution Center
1750 Archibald Avenue
Ontario, CA 91760



INSTALLATION INSTRUCTIONS

399-LED PENDANTS

PD-39947

MODERN FORMS

PREPARATION

1. Shut off the power at the circuit breaker and remove existing fixture, including the crossbar.
2. Carefully unpack your new fixture and lay out all the parts on a clear area. Be careful not to lose any small parts necessary for installation.

MOUNTING THE FIXTURE (Fig. 1)

3. Remove the mounting screw (D) from the mounting back plate.
 4. Drill holes in the wall aligned with the key holes located in the mounting plate, insert the plastic anchors (C).
 5. Secure the mounting plate to the junction box using the screws provided with the junction box. Fasten the back plate to the wall with the plastic anchors using the wood screws (B) provided.
- Note: (i) Using any other non-original-manufacturer provided junction box screw may result in safety issue;
(ii) The side of the mounting plate marked "GND" must face out.
6. Unscrew the hexagonal nut inside of the canopy, take out the swivel.
 7. Choose suitable rod for desired length. Thread the fixture wire through the rods, swivel and canopy. Connect the canopy, swivel, rods and fixture. Make sure all are tightened, then screw up the swivel as before.

Hook the safety cord to the mounting plate. PS:PD-39947 have 2PCS safety cord.

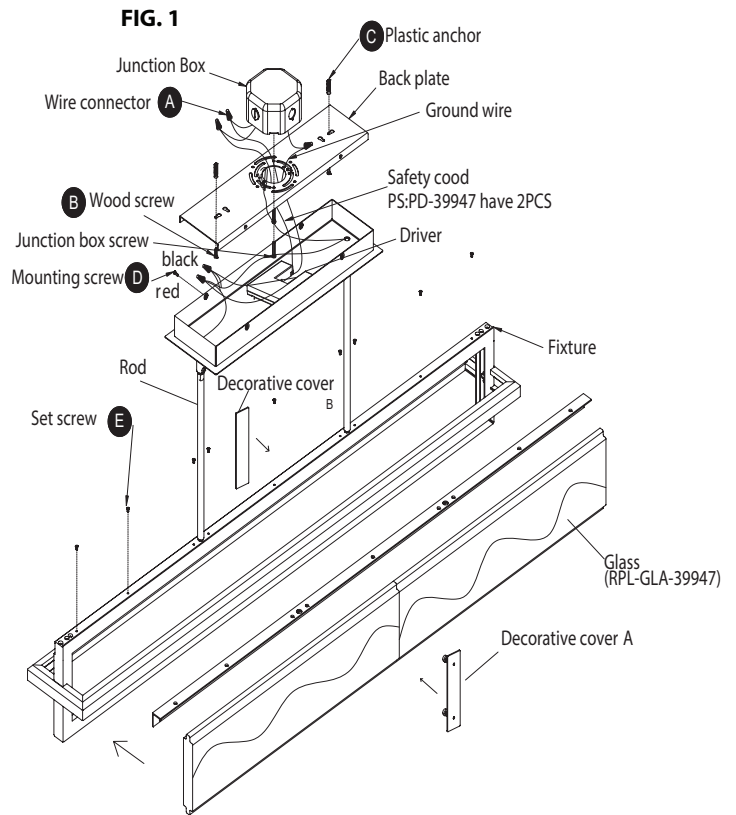

CONNECTING THE WIRES (Fig. 2)

9. Connect the driver's input wires to junction box wires, connect the driver's output wire to fixture wire, making sure that all wire connectors (A) are secured. If your outlet box has a green or bare copper ground wire, connect the fixture's ground wire to it. Otherwise, connect the fixture's ground wire directly to the back plate using the green screw provided. After wires are connected, tuck them carefully inside the junction box.

COMPLETING THE INSTALLATION

10. Secure the fixture to the back plate using the mounting screw (D).
11. Remove the glass set screw (E) from the frame, insert the glass, install back the screw to fix the glass.
12. Separate the decorative covers A and B and attach them to the middle joint of the glass using magnetism.

NOTE: DIMMING WIRING INFORMATION (Fig. 3)

13. This fixture features electronic low voltage (ELV or TRAIC) or 0-10V dimming capabilities. See notes below for specific dimming wires information.
14. To utilize ELV or TRAIC dimming: use wires black (hot), white (neutral) and bare copper ground wire (ground).
15. To utilize 0-10V dimming: use wire purple (dim+), gray (dim-), black (hot), white (neutral) and bare copper ground wire (ground)

NOTE: Make sure to connect 0-10V prior to power-up the fixture in order to allow the 0-10V dimming to function properly.

Fig. 2 Wiring

	Fixture Wires Black or Smooth	House Wires Black (Hot)
	Fixture Wires White or Ribbed	House Wires White (Neutral)
	Fixture Wires Bare wire (Ground)	House Wires Green or Bare Copper (Ground)

Fig. 3

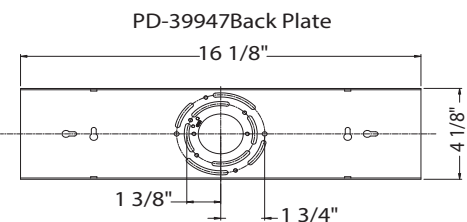
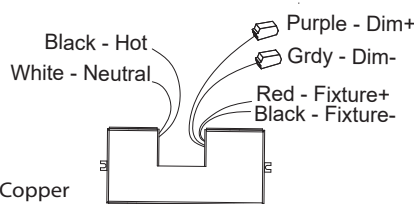

modernforms.com
Phone (800) 526.2588
Fax (800) 526.2585

Headquarters/Eastern Distribution Center
44 Harbor Park Drive
Port Washington, NY 11050

Central Distribution Center
1600 Distribution Ct
Lithia Springs, GA 30122

Western Distribution Center
1750 Archibald Avenue
Ontario, CA 91760

